

Assembly Instruction

CAST ALUMINIUM PATIO LOVESEAT CHAIR

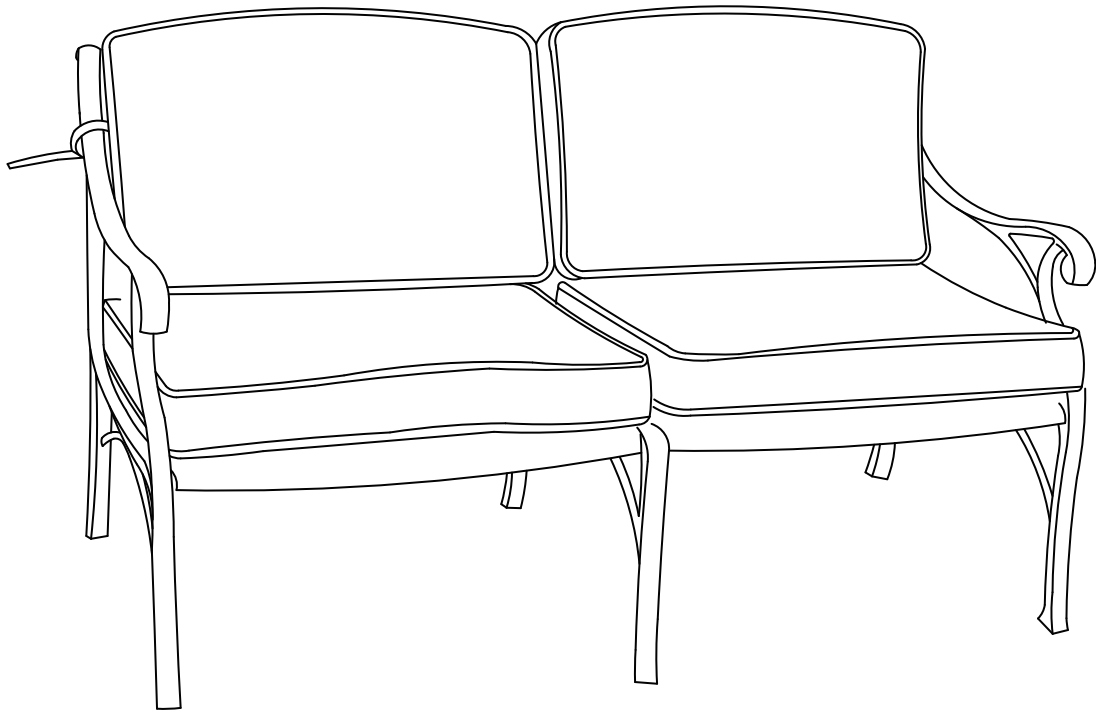





Carefully unpack and identify each component before beginning assembly. Before you begin, please refer to parts list to make sure that you have all parts. Please take care when assembling the unit and always place the parts on a clean, soft surface. If you require assistance with assembly or parts, please call 888-357-7263.

PRE-ASSEMBLY PREPARATION



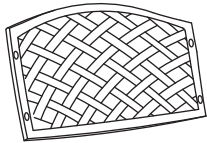

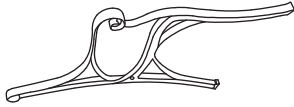
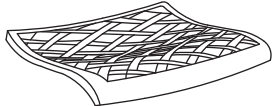

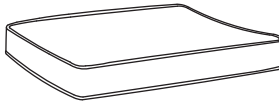
WARNING! DO NOT LET CHILDREN PLAY IN OR AROUND THE UNIT DUE TO THE POSSIBLE RISK OF FINGER ENTRAPMENT



- Please read through this instruction before beginning assembly.
- Two adults assembly is recommended.
- Clear out the space for assembly and lay out all parts base on Parts List, extra room will allow you to easily determine if all the pieces are present.
- Save all packing materials until assembly is complete to avoid accidentally discarding smaller parts or hardware.
- Keep small parts and pieces away from children until fully assembly.
- **Do not fully tighten the bolts until all have been inserted and hand tightened.**
- Please check for any loose screws and tighten them before use.

PANEL AND FITTINGS IDENTIFICATION

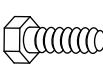
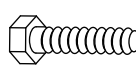
<p>Backrest Panel (A)</p>  <p>Qty: 2</p>	<p>Right Arm Panel (B)</p>  <p>Qty: 1</p>	<p>Left Arm Panel (C)</p>  <p>Qty: 1</p>	<p>Seat Panel (D)</p>  <p>Qty: 2</p>
<p>Middle Arm Panel (E)</p>  <p>Qty: 1</p>	<p>Back Cushion (F)</p>  <p>Qty: 2</p>	<p>Seat Cushion (G)</p>  <p>Qty: 2</p>	

HARDWARE LIST

<p>Bolt (H) M6*28mm</p>  <p>Qty: 9</p>	<p>Washer (I) M6</p>  <p>Qty: 9</p>	<p>Spring Washer (J) M6</p>  <p>Qty: 9</p>	<p>Nut (K) M6</p>  <p>Qty: 9</p>
<p>Nut Cap (L) M6</p>  <p>Qty: 9</p>	<p>Bolt (M) M8*30mm</p>  <p>Qty: 5</p>	<p>Bolt (N) M8*45mm</p>  <p>Qty: 3</p>	<p>Washer (O) M8</p>  <p>Qty: 7</p>

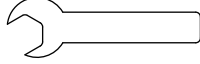
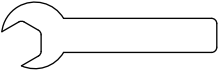



<p>Spring Washer (P) M8</p>  <p>Qty: 7</p>	<p>Nut (Q) M8</p>  <p>Qty: 7</p>	<p>Nut cap (R) M8</p>  <p>Qty: 7</p>	<p>Wrench (S) M6</p>  <p>Qty: 1</p>
<p>Wrench (T) M8</p>  <p>Qty: 1</p>			

Step 1

Stand Left Arm Panel (C) up.

Attach Left Arm Panel (C) to Seat Panel (D) by using 2 Bolts (M), 2 Washers (O), 2 Spring Washers (P), 2 Nuts (Q) with Wrench (T) as shown below.



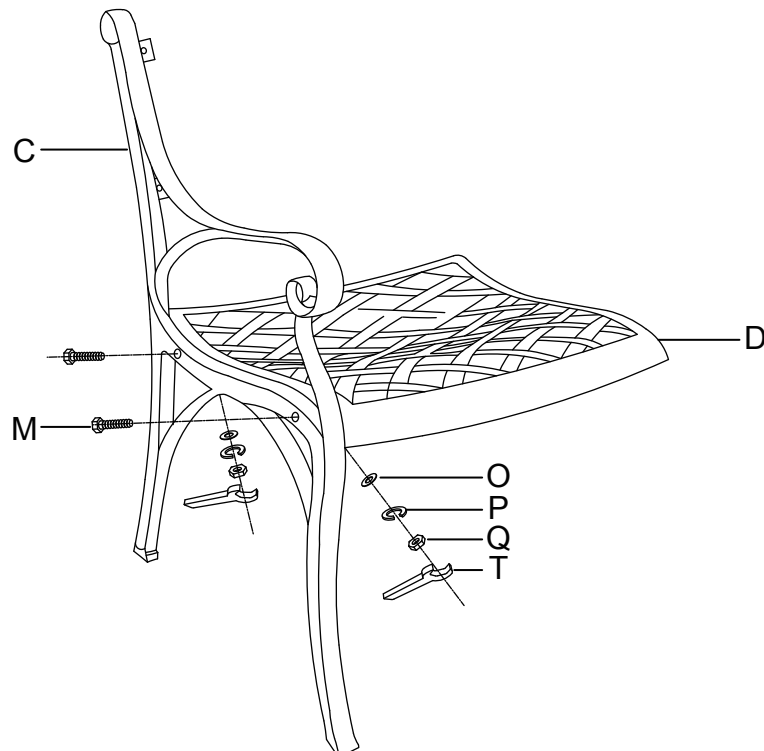

DO NOT FULLY TIGHTEN BOLTS.

M X 2	O X 2	P X 2	Q X 2
			

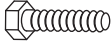

Step 2



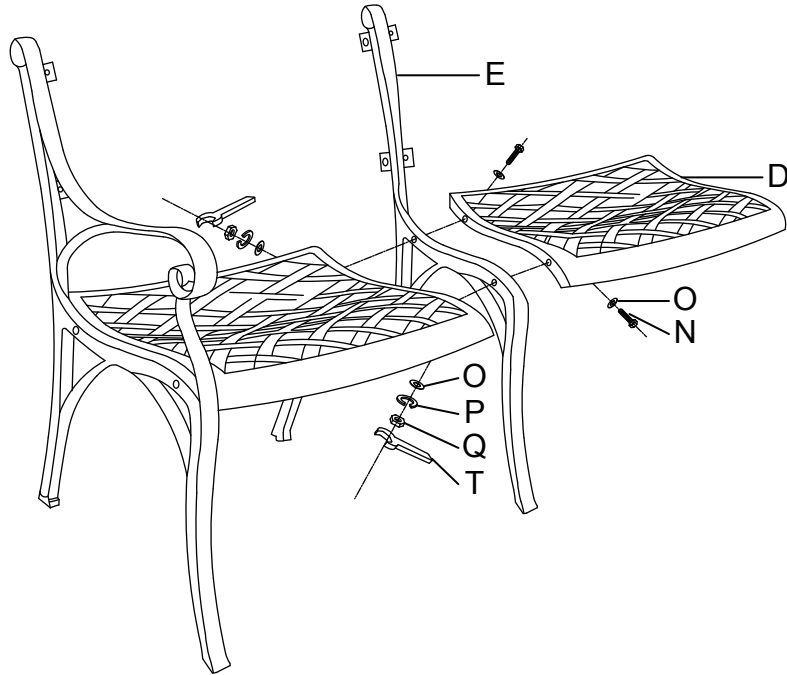

Attach Seat Panel (D) to Middle Arm Panel (E) by using 2 Bolts (N), 2 Washers (O), 2 Spring Washers (P), 2 Nuts (Q) with Wrench (T) as shown below.
DO NOT FULLY TIGHTEN BOLTS.

N X 2	O X 2	P X 2	Q X 2
			



Step 3

Attach Right Arm Panel (B) to Seat Panel (D) by using 2 Bolts (M), 2 Washers (O), 2 Spring Washers (P), 2 Nuts (Q) with Wrench (T) as shown below.
DO NOT FULLY TIGHTEN BOLTS.



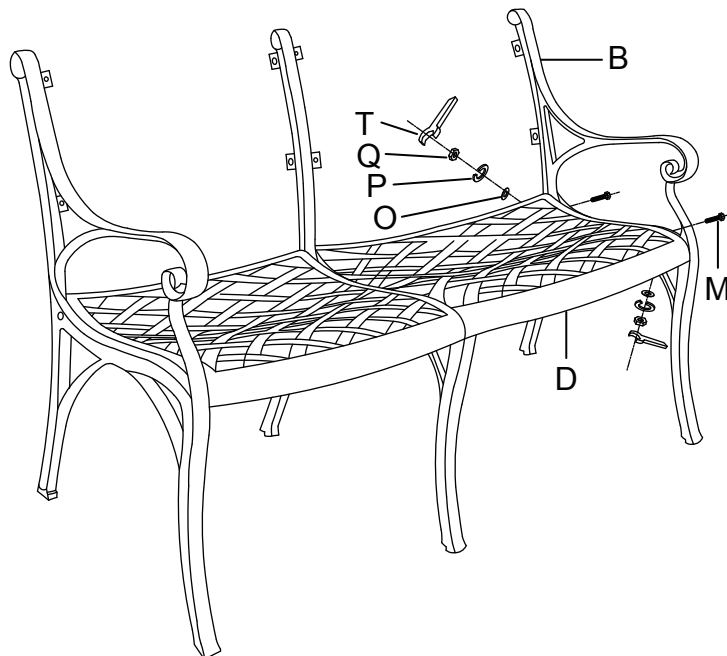

M X 2	O X 2	P X 2	Q X 2
			



Step 4

Attach Backrest Panel (A) to Left Arm Panel (C) and Middle Arm Panel (E) by using 4 Bolts (H), 4 Washers (I), 4 Spring Washers (J), 4 Nuts (K) with Wrench (S) as shown below.



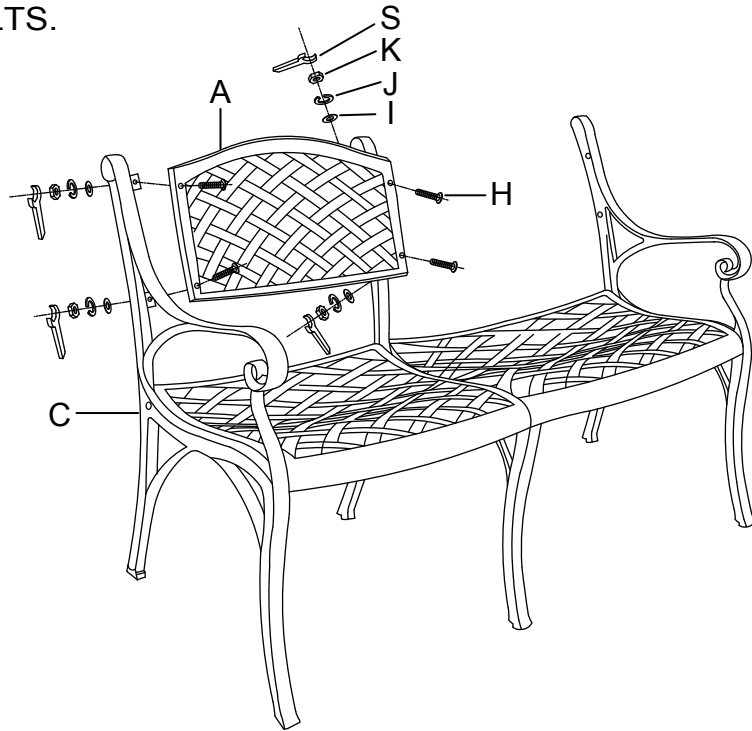

DO NOT FULLY TIGHTEN BOLTS.

H X 4	I X 4	J X 4	K X 4
			



Step 5

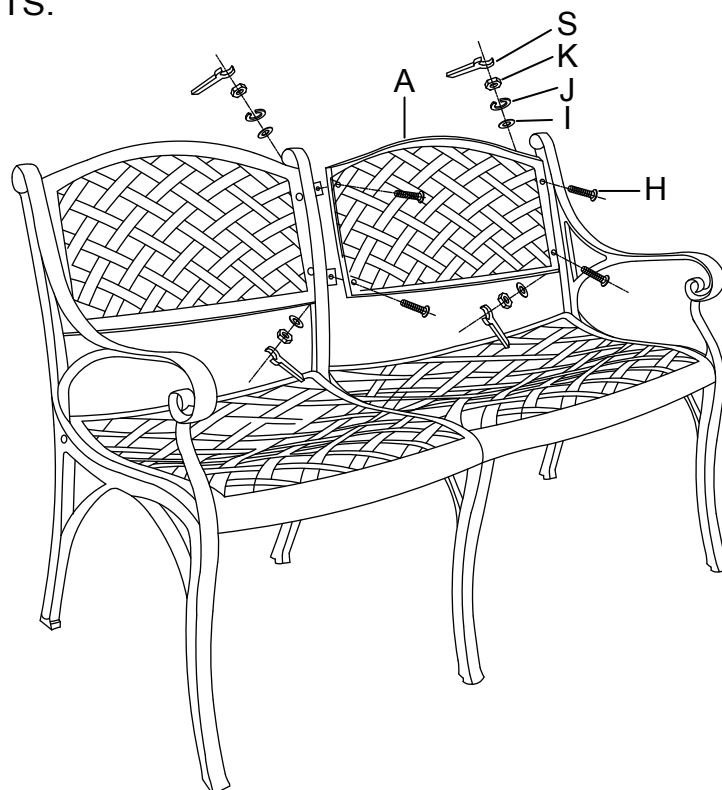

Repeat step 4 to attach the other Backrest Panel(A) to Right Arm Panel(B). DO NOT FULLY TIGHTEN BOLTS.

H X 4	I X 4	J X 4	K X 4
			



Step 6

Now fully and securely tighten all nuts at all joints.
Add Nut Caps (L) on bolt ends behind Backrest Panel (A) and Nut Caps (R) on bolt ends under Seat Panel (D) to protect skin or clothing from getting snagged.

L X 8	R X 6
	

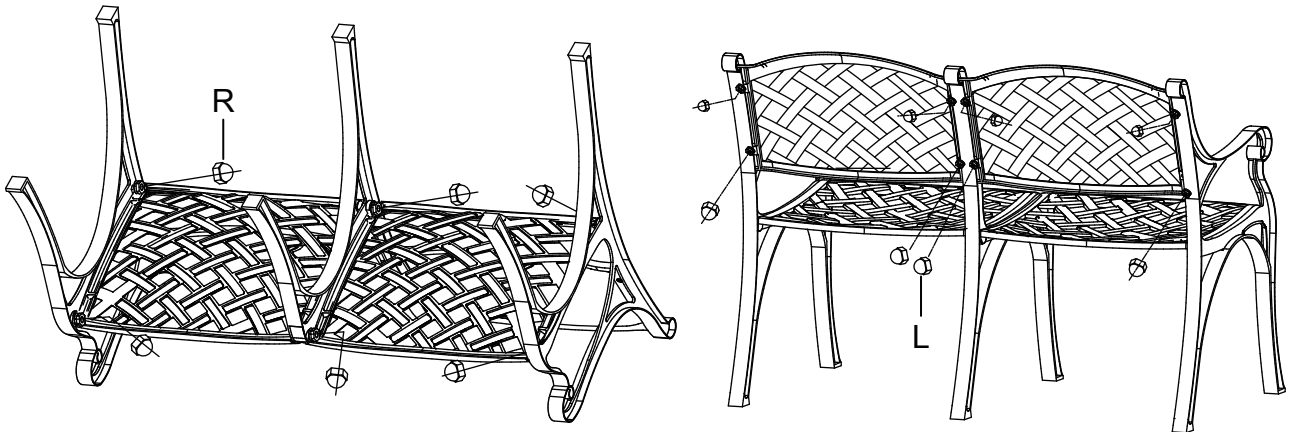

Step 7

Adjust the pre-installed levellers at the bottom of the chair legs until the chair is level with the ground.

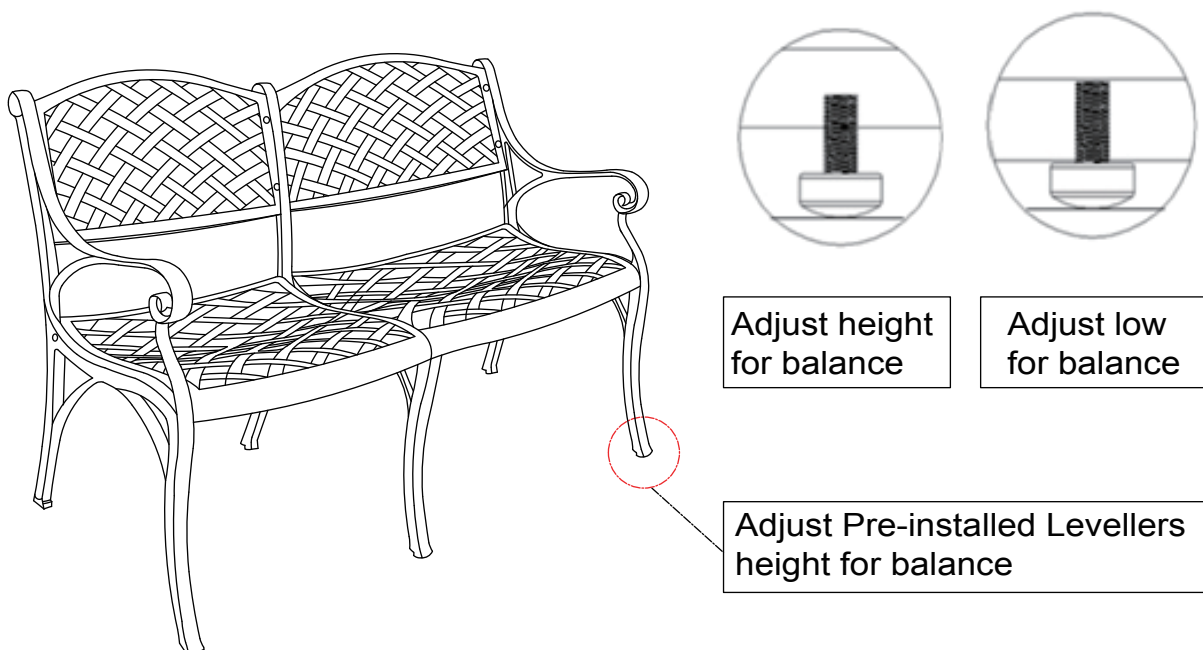

Step 8

Put Back Cushion (F) and Seat Cushion (G) on the Chair. Inspect it and make sure all parts are adequately connected. Your chair is ready for use.

Caution: This Chair can only be used on a flat, level surface.

