

ASSEMBLY INSTRUCTION

Step 1

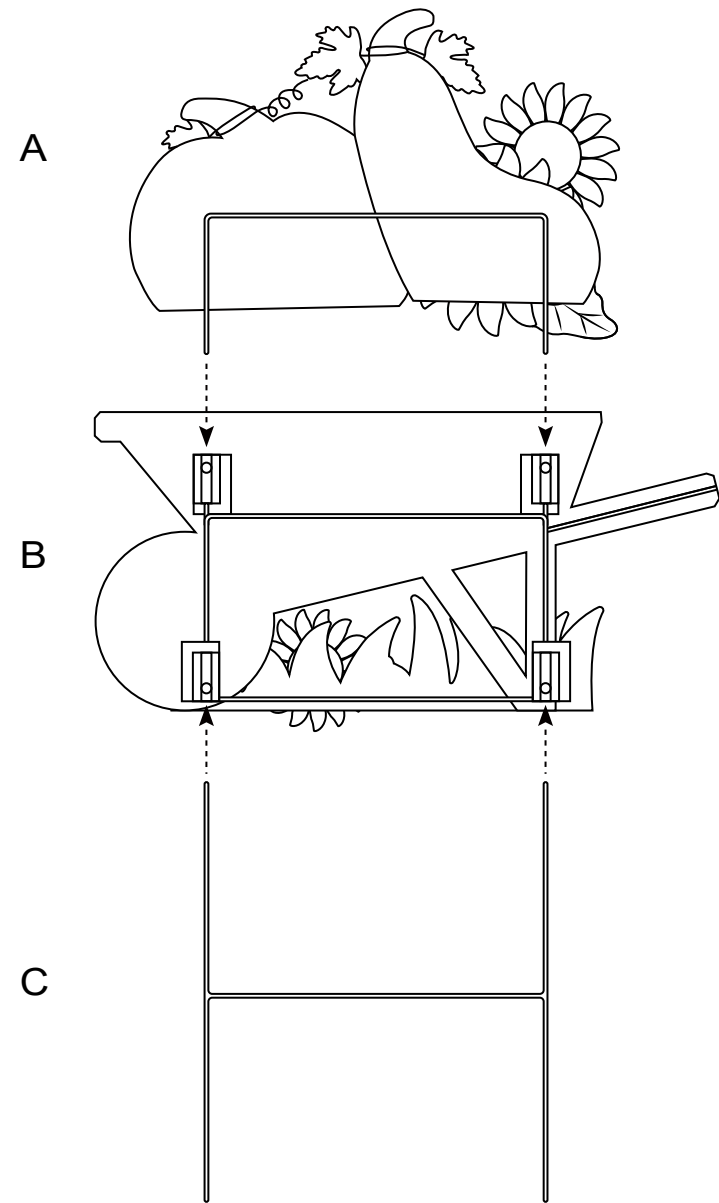

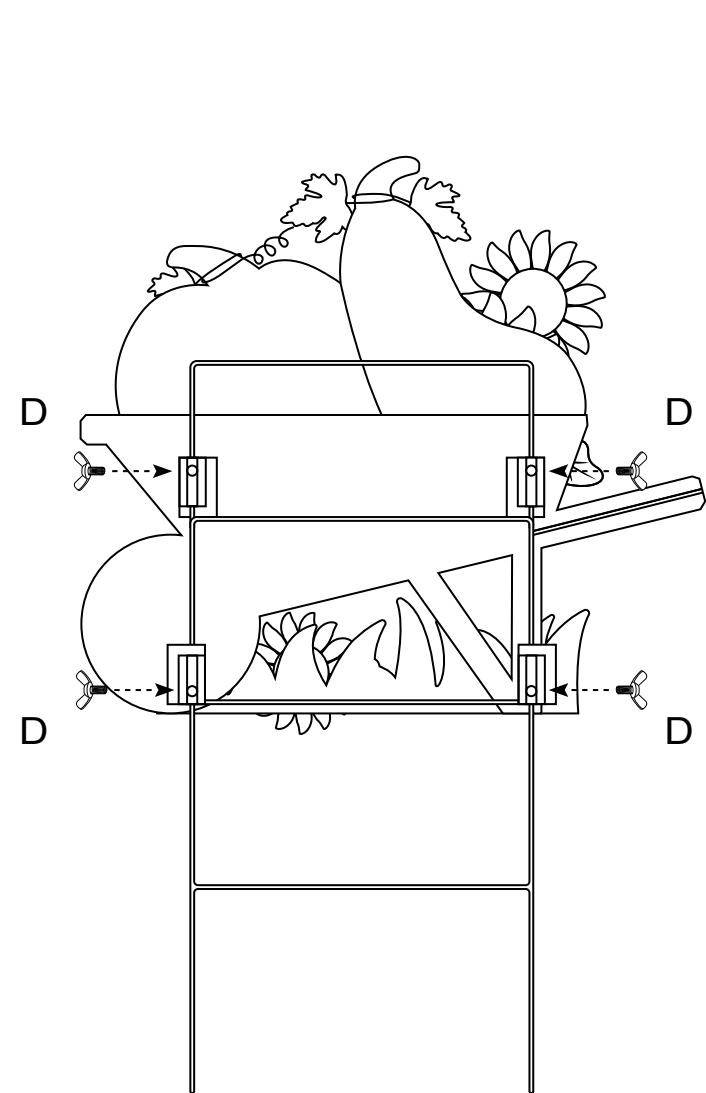

Step 2

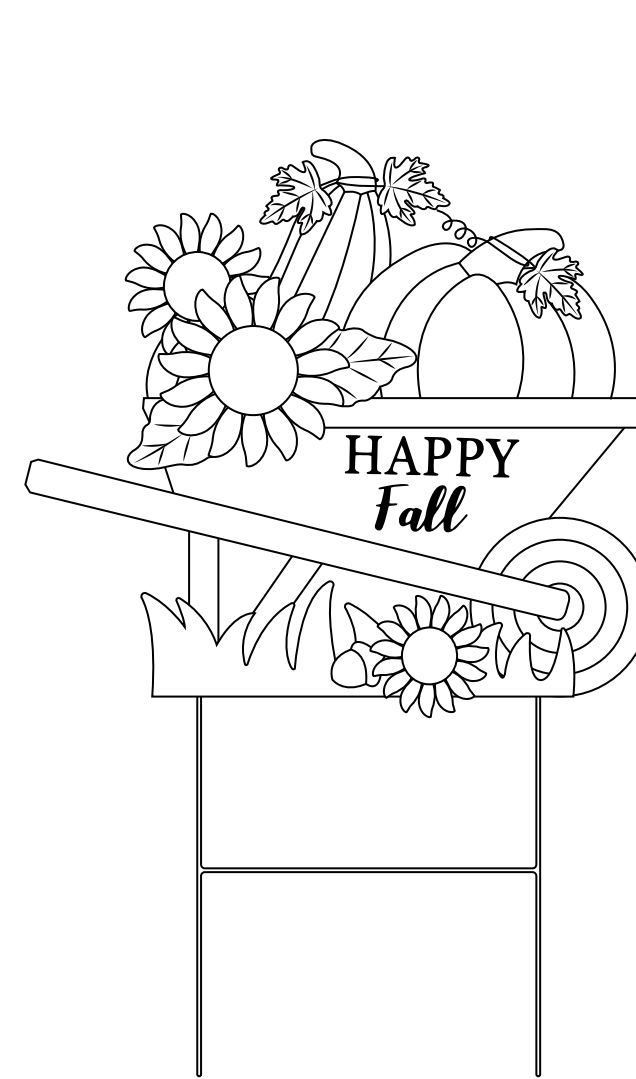

Step 3

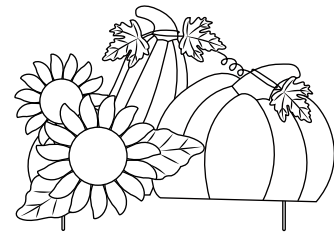
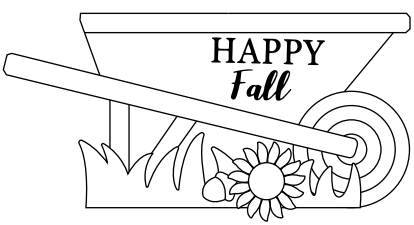
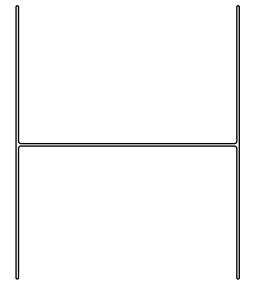

HARDWARE LIST		
CODE	PARTS	QTY.
A		1PC
B		1PC
C		1PC
D		4PCS